



SPECIFICATION

DVBT TUNER

Revision:1.0

1.SCOPE

The PDVBT-77GPCT is intended for the reception of DVB-T compliant MPEG2 signals (full TES 300 744 compliant) in combination with the tuner, all functions are integrated to deliver a corrected stream given DVB-T encoded signal (2K or 8K mode) with 7MHz or 8MHz bandwidth.

2.GENERAL SPECIFICATIONS

2-1. RECEIVING FREQUENCY RANGE :VHF 174~230MHz(I²C PLL CONTROLLER FROM UHF 470~858MHz OUTSIDE)

2-2. Temperature Range

Storage Temperature : -20°C ~ + 80°C

Operation Temperature : 0°C ~ + 50°C

2-3. Weight : 5g

3.TEST CONDITIONS

3-1. Test conditions : All data held under following conditions
: +25+/-2°C / Humidity : 45 ~ 65% RH

3-2. SUPPLY VOLTAGE :B1 3.3V +/-2% Ripple < 7mV
B2 1.2V +/-2% Ripple < 7mV



SPECIFICATION						
DVBT TUNER				Revision:1.0		
4.Electrical Specification						
NO	ITEM	CONDITION	MIN	TYP	MAX	NOTES
4-0.	RF input impedance	I-PEX CONNECTOR	50 OHM			
4-1.	Frequency range	UHF	470		858	MHz
		VHF HIGH	174		230	MHz
4-2.	Gain	UHF	20		40	dB
		VHF HIGH	25		45	dB
4-3.	Gain step	UHF		0.5		dB
		VHF HIGH		0.5		dB
4-4.	ICP (low gain)	UHF	-15			dBm
		VHF HIGH	-15			dBm
4-5.	ICP (high gain)	UHF	-35			dBm
		VHF HIGH	-35			dBm
4-6.	Input IP3 (low gain)	UHF	-5			dBm
		VHF HIGH	-5			dBm
4-7.	Input IP3 (high gain)	UHF	-25			dBm
		VHF HIGH	-25			dBm
4-8.	Noise Figure	UHF		3		dB
		VHF HIGH		3		dB
4-9.	Zin	UHF		50		ohm
		VHF HIGH		50		ohm
4-10.	MAX RF input 64 QAM	UHF			-13	dBm
		VHF HIGH			-6	dBm
4-11.	CONSUMPTION CURRENT	:B1 3.3V		160		mA
		B2 1.2V		160		mA



SPECIFICATION						
DVBT TUNER						
Revision:1.0						
NO.	ITEM	CONDITION	MIN.	TYP.	MAX.	NOTES.
5. Electrical Characteristics Control refer to DIB7070GP data sheet						
5-1	C/N in AWGN 8MHz,G1/4,RF=-50dBm RS uncorrected error=0	8K 64QAM R2/3		18.7		dB
		8K 64QAM R1/2		16.5		dB
		8K 16QAM R3/4		14.6		dB
		8K 16QAM R2/3		13.1		dB
		8K QPSK R1/2		5.1		dB
5-2	Sensitivity in AWGN 8MHz,GI=1/4 RS uncorrected error=0	8K 64QAM R7/8		-72		dBm
		8K 64QAM R2/3		-76		dBm
		8K 64QAM R1/2		-80		dBm
		8K 16QAM R3/4		-81		dBm
		8K 16QAM R2/3		-84		dBm
		8K QPSK R1/2		-91		dBm
5-3	C/N in 0dB Echo 8MHz,658MHz,G1/4,RF=-50dBm Crition:Picture Quality	8K 64QAM R3/4		27.6		dB
		8K 64QAM R2/3		23.2		dB
5-4	Echo Outside Guard Interval RS uncorrected error=0 8MHz,658MHz,RF=-50dBm	8K 64QAM R=3/4 GI=1/4 -/+260uS		15		dB(PATH LOSS)
		8K 64QAM R=2/3 GI=1/8 -/+260uS		12		dB(PATH LOSS)
5-5	Frequency Offset	8K,8MHz,64QAM,R2/3, G1/8,-60dBm	-300		300	KHz
5-6	Mobile Performance RF Level=-50dBm,658MHz 8MHz,C/N=OFF Average Packet Error Rate 5×10^{-3}	2K,16QAM,R=3/4,GI=1/4		350		km/h
		8K,64QAM,R=1/2,GI=1/4		115		km/h
		8K,64QAM,R=2/3,GI=1/4		95		km/h

SPECIFICATION

DVBT TUNER

Revision:1.0

6.0 Application:

To gain good sensitivity under 64QAM, code rate: 7/8

please supply PIN 16 B1 1.2V respectively; Please do not share voltage with other system.

Circuit block diagram

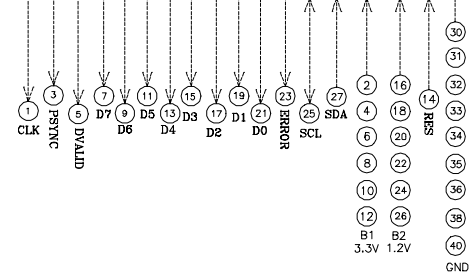
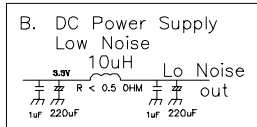
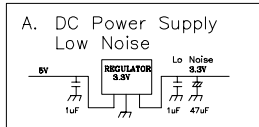
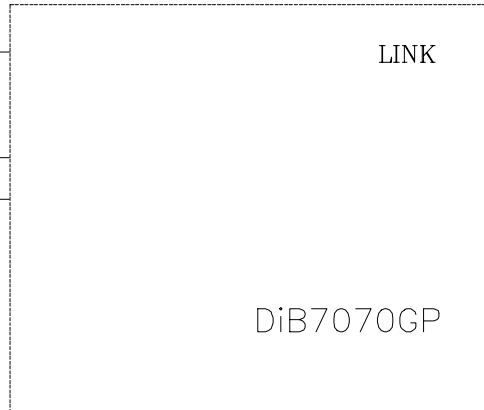
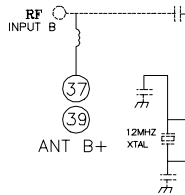
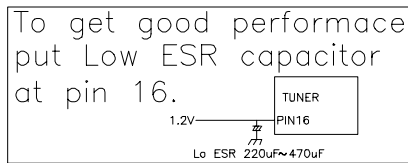



SPECIFICATION

DVBT TUNER

Revision:1.0

7. **Electrostatic discharge**7.1 **Test**

Each front-end must be capable of normal performance following its subsection to the following tests:

MIL STD 883C HBM

Test is performed with a voltage discharge from a 100 **PF** capacitor over a 1500 **OHM** series resistance in the discharge path. There is a direct contact between the test probe head and the unit under test, using the test points and conditions detailed below:

- o Test to pins 1 through 18:
3 successive ESD discharges of **+/-2 KVDC** between each pin and the front-end frame.

IEC 1000-4-2

Test is performed with a voltage discharge from a 150 **PF** capacitor over a 330 **OHM** series resistance in the discharge path. There is a direct contact between the test probe head and the unit under test, using the test points and conditions detailed below:

- o Test for antenna input socket **+/-2 KVDC**

7.2 **Handling**

Anyone handling a front-end must wear a properly grounded anti-static discharge bracelet to minimize **ESD** damage.

After each front-end is aligned and tested, it will be packed with anti-static material prior to transportation and storage. This package is to remain in place until the front-end is assembled and soldered onto the receiver main board.



SPECIFICATION

DVBT TUNER

Revision:1.0

8 Reliability test procedure & conditions

Note:Room temperature = 25°C +/- 2°C

8.1 Heat load test

- o Measure the DUTs at room temperature
- o Load the DUTs into chamber of the following conditions:

Temperature = 60 °C
Period = 500 hrs
Cycle = 1.5 hrs on; 0.5 hrs off
Quantity = 10 pcs

- o Cool-down 0.5 hr at room temperature, then measured the DUTs within 1 hr
- o The test shall be continued to 1000 cycles for information only

8.2 Humidity load test

- o Measure the DUTs at room temperature
- o Load the DUTs into chamber of the following conditions:

Temperature = 40 +/- 5 °C
Period = 24 hrs
Cycle = constantly on
Quantity = 24 pcs

- o Cool-down 0.5 hr at room temperature, then measured the DUTs within 1 hr
- o Load the DUTs again into chamber of the following conditions:

Temperature = 40+/-5°C
Humidity = 90 to 95%
Period = 500 hrs
Cycle = 1.5 hrs on; 0.5 hr off
Quantity = 20 pcs

- o Cool down 0.5hr at room temperature, then measured the DUTs within 1 hr



SPECIFICATION

DVBT TUNER

Revision:1.0

8.6 Vibration test

- o Frequency: 3.5 Hz
- o Vertical amplitude: 15 to 25 mm
- o Duration: 1 hr
- o Quantity: 1 carton

8.7 Drop test

- o Packaged apparatus: <or = 50 kg
- o Height: depend on weight
- o 1 corner + 3 edger + 6 faces

Drop on the weakest corner (point G)

Drop on the shortest edge on contact with point G

Drop on average edge in contact with point G

Drop on the longest edge in contact with point G

Drop flat wise on the side of minimum surface

Drop flat wise on the side of opposite minimum surface

Drop flat wise on the side of average surface

Drop flat wise on the side of opposite average surface

Drop flat wise on the side of maximum surface

Drop flat wise on the side of opposite maximum surface

- o Quantity :1 carton

8.8 Life test

- o Measure the DUTs at room temperature
- o Load the DUTs into chamber of the following conditions:

Temperature = 60 °C

Period = 500 hrs

Cycle = constantly on

Quantity = 20 pcs

- o Cool down 0.5 hr at room temperature, then measured the DUTs within 1hr

SPECIFICATION

DVBT TUNER

Revision:1.0

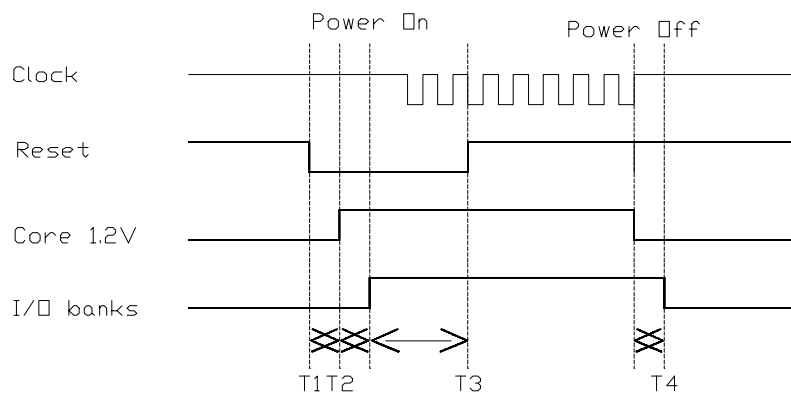

power on and off sequence

1. DiB IC can support I2C clock up to 1MHZ
2. After reset release,you can send immediatly I2C messages.Maybe wait 1-2 clock cycle before sending I2C message,just to be sure.
3. The only limit is $T3 > 10\text{ms}$.

SPECIFICATION

DVBT TUNER

Revision:1.0

NOTE 1.TOLERANCES ARE ± 0.5 .
UNLESS OTHERWISE SPECIFIED.

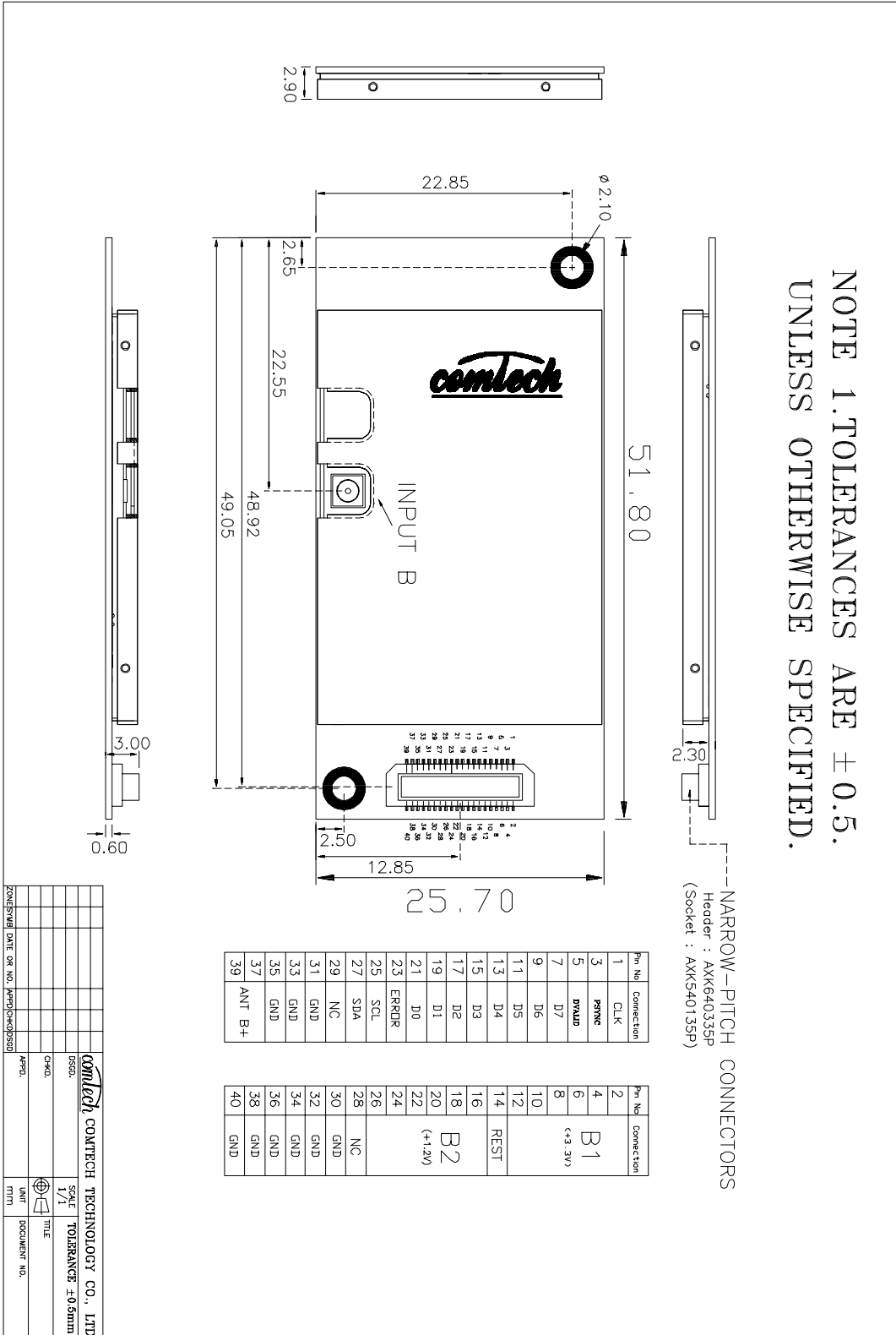

DESIGN	COMTECH TECHNOLOGY CO., LTD
SCALE	1/1
TITLE	TOLERANCE ± 0.5 mm
DATE	
NO.	
APPRO.	
UNIT	MM
DOCUMENT NO.	